

CHAPTER 6

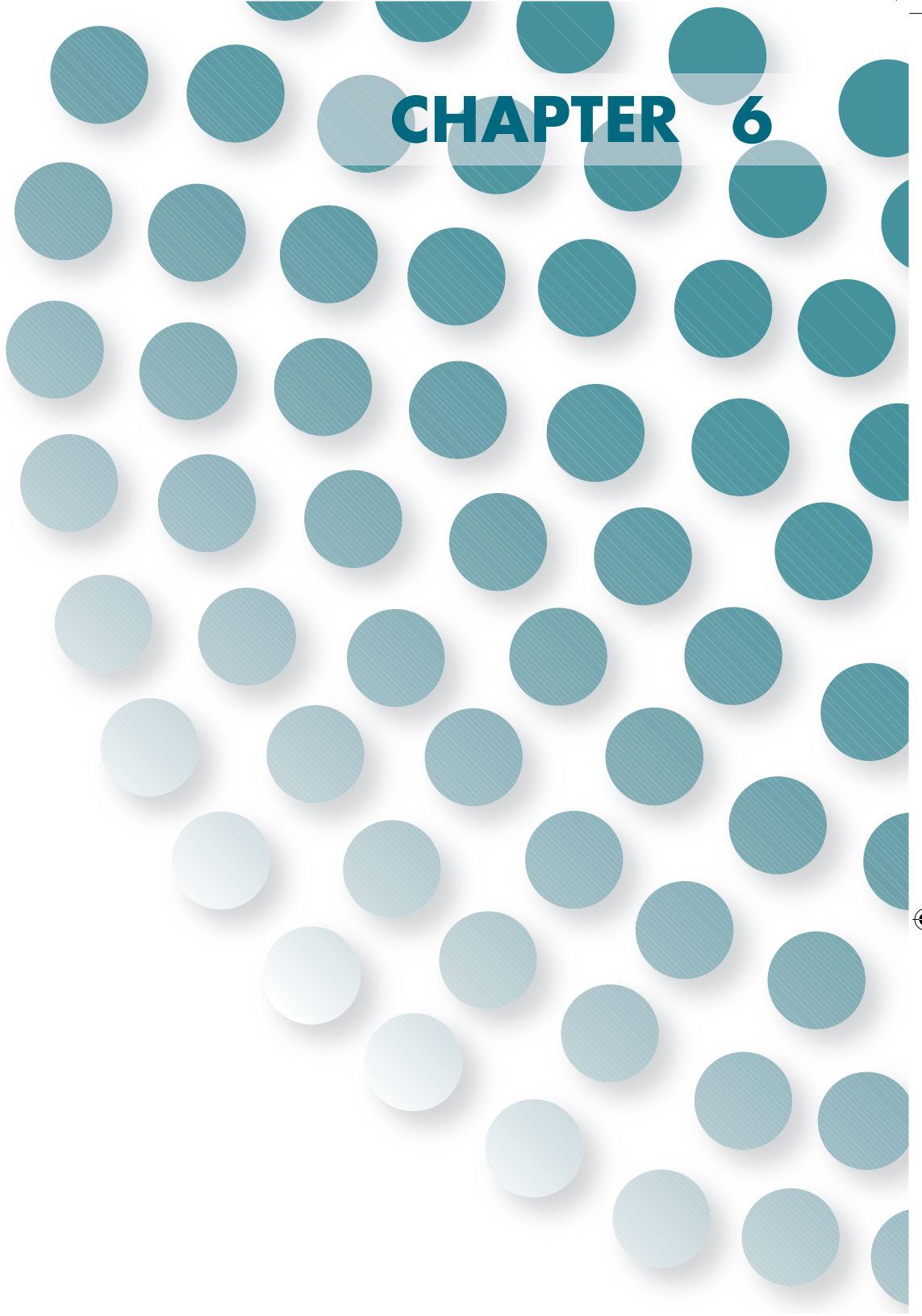

DOOR TRANSFER GRILLES



CONTENTS

Introduction, Features & Characteristics.

Models, Profiles used in Door Grilles.

Mounting Instructions, Face Screw Fixing, Effective Area Values.

Selection Diagrams.

Ordering Data.



BCI Door Transfer Grilles of the DG Model are particularly designed to allow the passage of air from a conditioned space to another while preventing vision. They are widely used, not only in doors, panels or partitions, but also in places of conventional exhaust and return air grilles where it's required that the interior of the duct be hidden.

Features & Characteristics :

- Construction : Frame & blades are made of high quality Extruded Aluminium Profiles of 6063 Alloy.
- Frame Flange width : 30 mm.
- Blades : Inverted " V " horizontal cross section louvers arranged to overlap each other to be " Sight – Tight " when viewed from any angle.
- Blades pitch : blades are spaced at a distance of 20 mm.
- The inverted " V " louver cross section not only blocks vision, but also provides additional strength and rigid construction.
- Available in wide variety of standard neck sizes ranging from 200 x 100 up to 1200 x 500 mm (other None – Standard Sizes are available on request).
- Telescopic frame suitable for doors or partitions from 25 – 55 mm thick (Fixed on both sides of the door).
- The frame of the Door Transfer Grille is composed of two parts, one part is the fixed one, holding the core and can be fixed to one side of the door or partition. While the other part, the sliding one, is fixed to the other side of the door or partition. Thus the sliding frame gives the facility of installing this grille to different thicknesses of doors or partitions.
- The large free area (up to 70 %) is capable of transferring high air volumes at minimum pressure loss and noise level.
- The frame mounting holes are dimpled, allowing for a counter-sunk fastener head appearance.
- Available with Foam type Rubber Gasket for air sealing (provided as an option).
- Mounting instructions : see page No. DG – 03.
- Surface Finishes : see page No. DG – 05.



Construction and Dimensional Details

Model DG

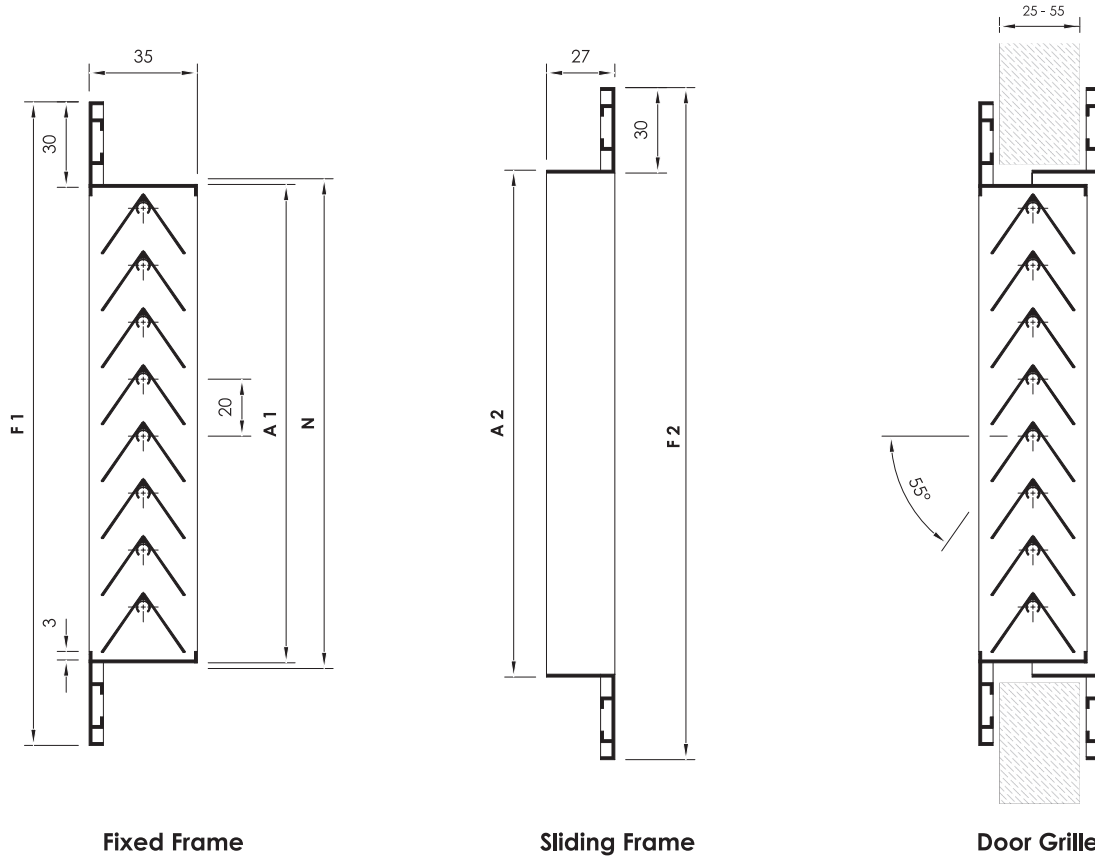

N : Nominal / Listed Size = Length (L) x Height (H) in mm
Case I: Specified height (H) in cm is even figure :
A 1 = Actual Size = (L-10) x (H-15)
F 1 = Face Size = (L+50) x (H+45)
A 2 = Actual Size = (L-5) x (H-10)
F 2 = Face Size = (L+55) x (H+50)

Case II: Specified height (H) in cm is odd figure :
A 1 = Actual Size = (L-10) x (H-5)
F 1 = Face Size = (L+50) x (H+55)
A 2 = Actual Size = (L-5) x (H)
F 2 = Face Size = (L+55) x (H+60)

Cross Sectional Drawings for Profiles used in Door Transfer Grilles

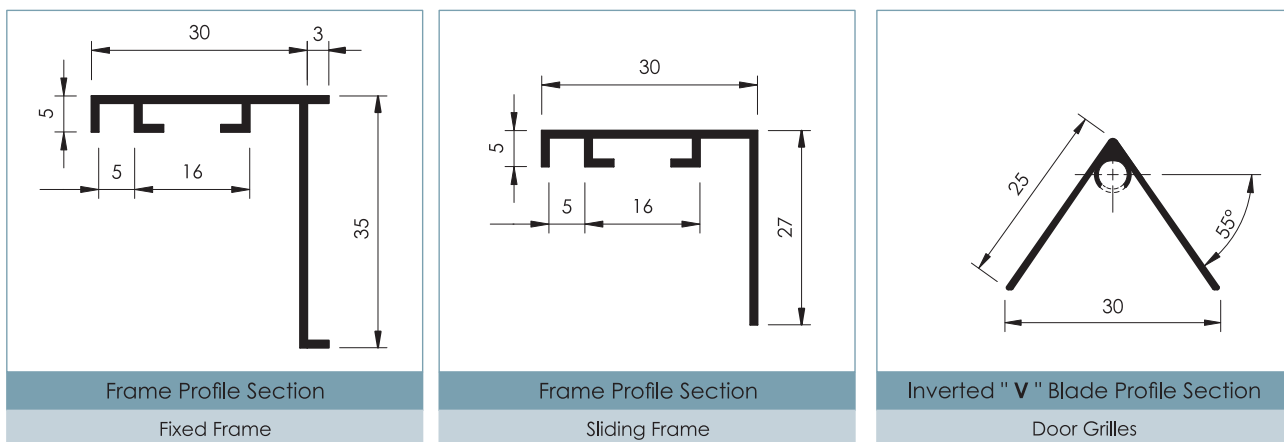

• All Dimensions are in mm and subject to ± 0.2 mm tolerance.

Mounting Instructions

Face Screw Fixing

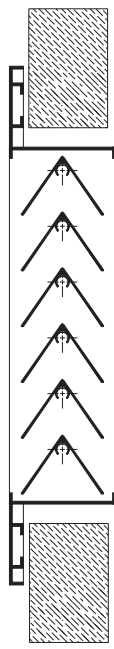

Step 1

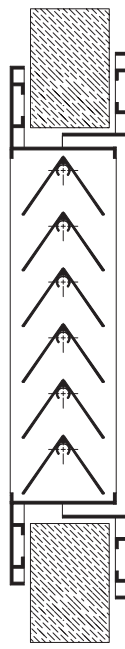

Step 2

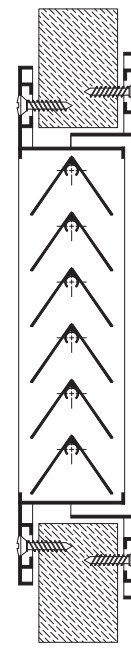

- Insert the counterframe in the door partition opening and fix with screws using the holes on the border edge.
- On the opposite part, install the grille with frame in away that allows the telescopic part to open into the counterframe. Fix with screws.

- The Door Grille is fixed to the door or partition by means of visible counter - sunk screws.

TABLE DG - 01

Effective Area Values for Door Transfer Grilles in (m ²)								
L	H	100	150	200	250	300	400	500
150		0.005	0.008					
200		0.010	0.018	0.027				
250		0.014	0.025	0.040	0.045			
300		0.016	0.029	0.043	0.057	0.070		
400		0.021	0.039	0.056	0.073	0.090	0.120	
500		0.027	0.050	0.070	0.095	0.120	0.150	0.190
600		0.033	0.060	0.090	0.120	0.150	0.190	0.260
800		0.043	0.080	0.120	0.155	0.190	0.260	0.320
1000		0.056	0.100	0.150	0.190	0.230	0.320	0.400
1200		0.070	0.120	0.190	0.225	0.260	0.400	0.520

• L & H Dimensions are in mm.

Engineering and Performance Data

Selection Diagrams

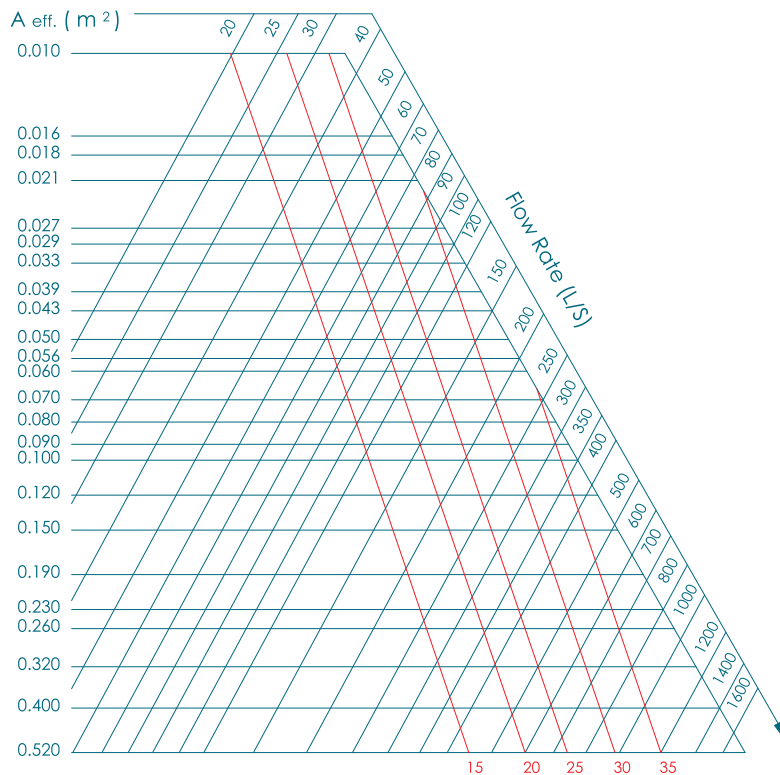

Illustrative Example :

Given Data :
 Nominal Size : 400 x 200 mm
 Air Flow Rate = 255 CFM = 120 (L/S)
 $A_{eff.} = 0.056 m^2$ (refer to table No. DG - 01).
 Apply the readings of flow rate and $A_{eff.}$ on the chart and read other data as below :
 Noise Level = 24 dB.
 $V_{eff.} = 2.2 m/s$.
 Pressure Drop = 21 pa.

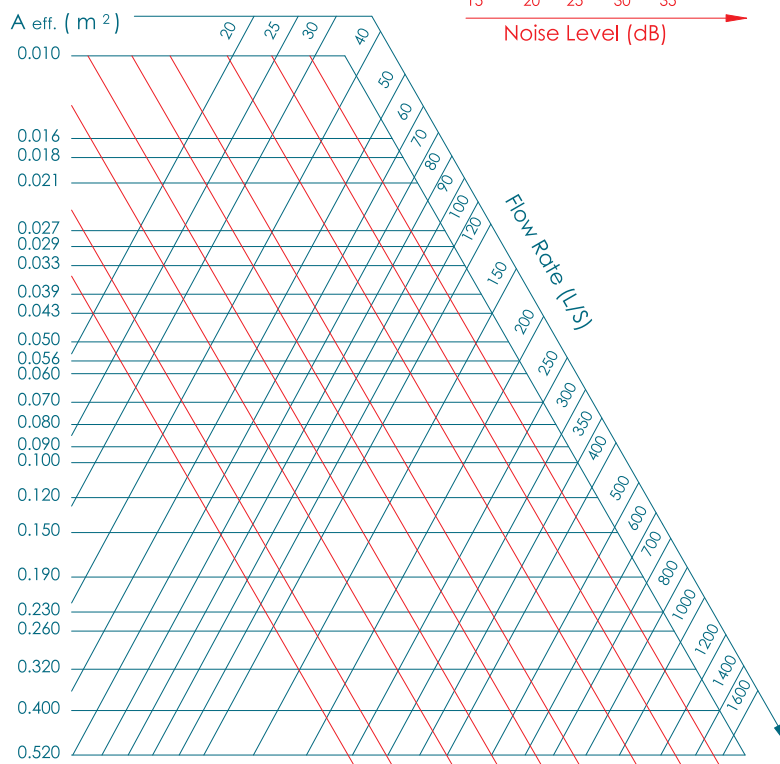

Ordering Data

- **Available Surface Finishes For Door Transfer Grilles :**

- Natural / Matt Silver Anodized .
- Powder Coating (Standard Colors are white RAL 9010/9016, other optional colors if required to be provided in RAL - No. only and charged extra).
- Aluminum in Mill Finish.
- Other Special Finishes (on request if available).

- **Ordering Specifications :**

Specify :

- 1 . Door Grille Description / Model (DG).
- 2 . Nominal / Neck size.
- 3 . Quantity.
- 4 . Door Grille Surface Finish.
- 5 . RAL – No.(only mention if powder coating surface finish is required).
- 6 . Rubber Gasket (only mention if required).

Example 1 :

1	2	3	4	5	6
DG	12" x 8" 300 x 200 (mm)	25	Powder Coating	9016	—

Example 2 :

1	2	3	4	5	6
DG	20" x 10" 500 x 250 (mm)	40	Silver Anodized	—	With Rubber Gasket

Example 3 :

1	2	3	4	5	6
DG	16" x 12" 400 x 300 (mm)	6	Mill Finish	—	—

DOOR TRANSFER GRILLES



A large area of the page is filled with horizontal dotted lines, providing a template for writing or drawing.